

A Bedside Call Unit
ZKRUNCIPWL10100

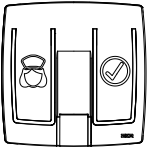

B Code Blue Unit
ZKRUNCIPCDBL101

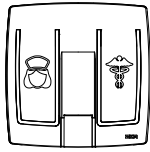

C ODCL Lamp Unit
ZKRUNCORTKLM P20
ZKRUNCORTKLM P10

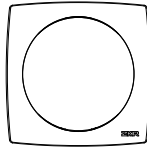

D WC Call Unit
ZKRUNCIPWC10100

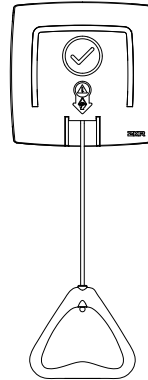

! CAUTION !

If the unit will be installed on a surface mounting box, complete this step first.

First pass the RJ45 cable through the slots in the back. After, Plug the RJ45 socket into place like in Step 1. Install the center orange part screwing metric #3 screws through the holes on the surface mounting box.

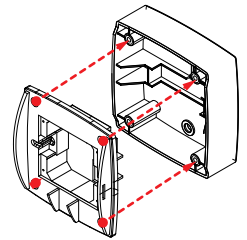
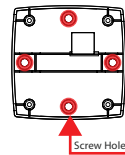

E Mid Part

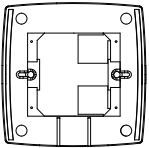

F Flush Mounted Box

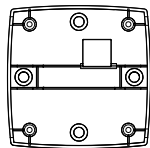

! The call units (A,B,C,D) are built on the same basis (E,F).

Step 1

Drill a 7cm diameter hole on the surface you want to make installation with the drilling saw.

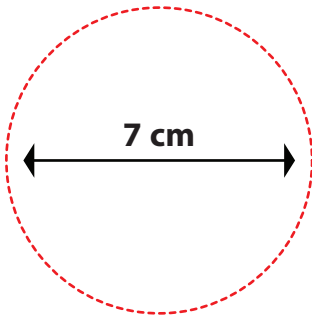

Step 2

Plug RJ45 jack to socket behind the center part (Orange Base Part).

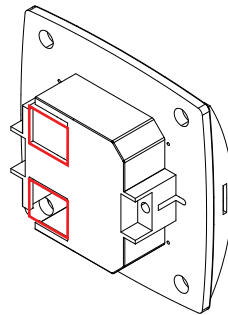

Step 3

Place the product into the (7 cm diameter) hole you drilled before.

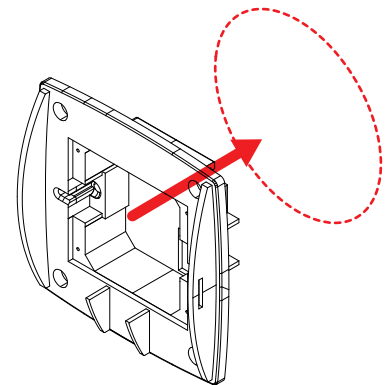

Step 4

Screw on both sides with a screwdriver. This way claws on the sides will open and fits the product.

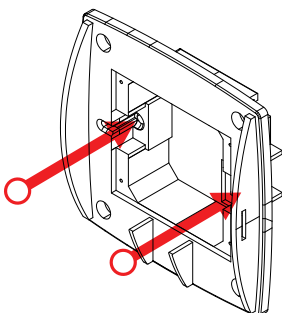

Step 4 Opt.2

If the mounting area is suitable, you can also use the screw holes in the corners.

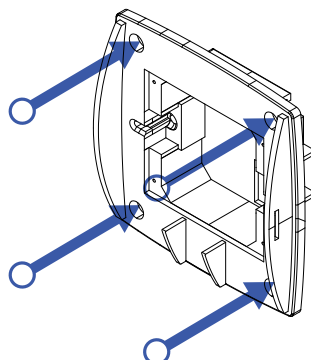

Step 5

Place left part of the top cover first. Place other side after. While placing the right side stretch the right wing gently.

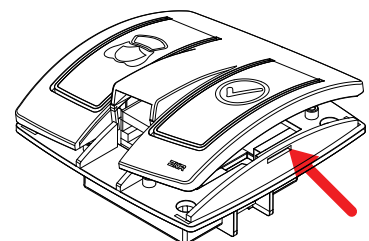

A Call Unit
LUXINFCDMGCN0001

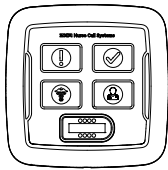

B Pull Cord Unit
LUXINFCDWCCN0001

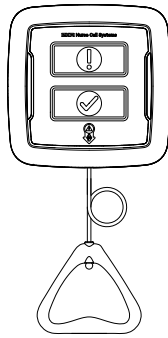

C Light Indicator
LUXINFCRRGBL0001

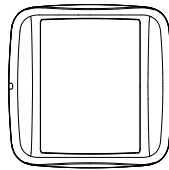

! CAUTION!
During the base part assembly, make sure that the locking snap fit on the part is at the bottom.

D Base Part

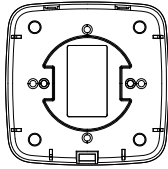

! CAUTION!
The call units (A,B,C) are built on the same basis (D).

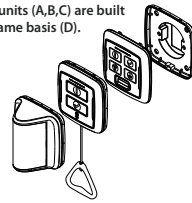

! CAUTION!

Up
Down

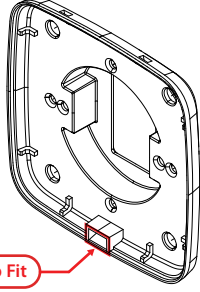

! Locking Snap Fit

Step 1

a Flat Surface Mounting
Drill a hole with a diameter of 7 cm on the surface you want to mount with the drill saw. Fix with screws from the corners

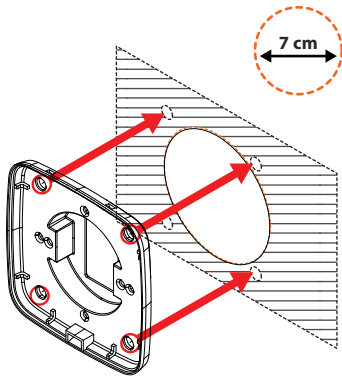

b Circular Flush Mounting Box
Fix it with the screw on the right and left sides

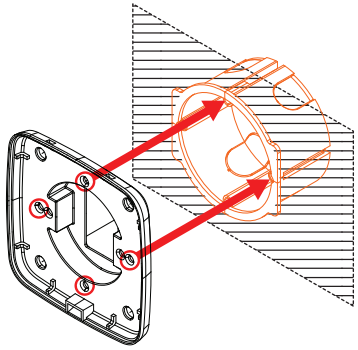

c Square Flush Mount Box
Fix it with the screw on the right and left sides

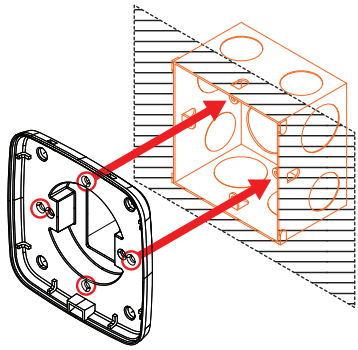

Step 2

Plug RJ45 socket to socket behind the unit

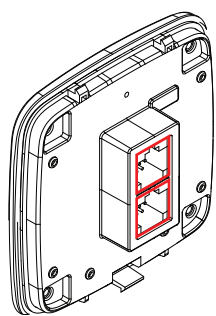

Step 3

a Insert the two upper tabs into the slots on the base piece

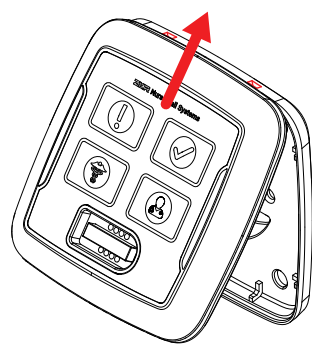

b Close the product downwards after the top two tabs are in place.

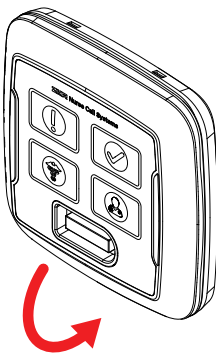

c The product will be closed when the tab on the bottom is located.

